**Product technical sheet****SOLO WD1448**

3 - 14 years



3 kids

35,2 m²**Material specification**

- The structure is made of a durable, moisture-resistant and low-temperature recycled composite,
- Platforms made of durable anti-slip and waterproof plywood or HPL plate,
- The covers are made of recycled HDPE panel, resistant to weather conditions
- Slides made of stainless steel with sides made of recycled HDPE boards, resistant to atmospheric conditions,
- Stainless steel bars,
- Stainless steel screws and/or screws covered with plastic caps,

**Physical development**

sliding





1
number of slides

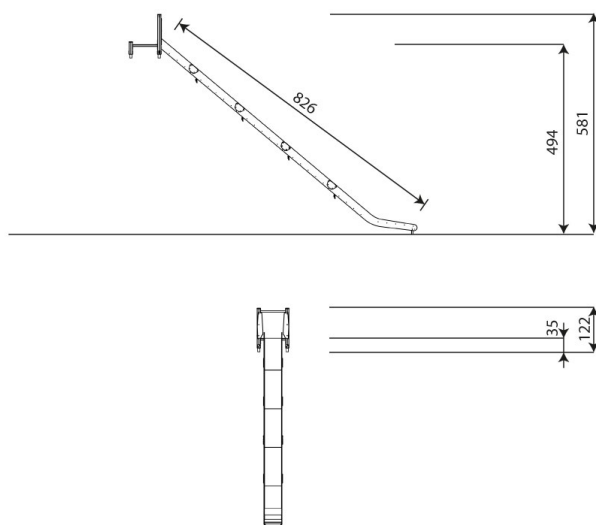
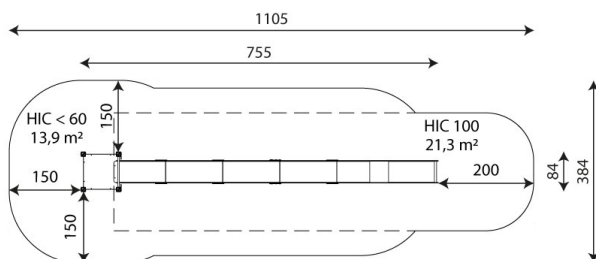

Product technical sheet

SOLO WD1448

Product data

Length	755 cm
Width	84 cm
Total height	581 cm
Age group	3 - 14 years
Number of users	3 kids
Safety zone	35,2 m2
Free fall height	<60 cm
The height of the platforms	35 cm
In accordance with norm EN	1176-1:2017
Weight of the heaviest part	32 kg
Dimensions of the largest part	247x121x52 cm
Availability of spare parts	YES
Installation time	3,0 h
Color options	

Data is subject to change without prior notice.

Additional information

- equipment intended for public playgrounds;
- equipment has a certificate issued by an accredited entity or a declaration of conformity;
- no sharp edges or chinks that would pose a danger of jimmieing the head, fingers or any other body parts;
- anchoring on flat surface, 80/70/60 cm deep;
- slide should not be installed southwards;
- render is for reference only, the actual appearance of the equipment and its color may vary;

Guarantee

30 30 year guarantee - Structural strength of steel and stainless steel components

15 15 year guarantee - Structural failure of steel and stainless steel, for dynamic equipment

10 10 year guarantee - Structural failure of high density polyethylene and high pressure laminates components

5 5 year guarantee - Corrosion of stainless steel and hot dip galvanized and powder coated components; against bark beetles and rot in case of wooden structural elements

Detailed information in the guarantee card



Surfaces according to EN 1176-1:2017

	Description (mm)	Layer thickness (cm)	Maximum fall heights (cm)
Turf/ top layer of soil (A,B,C)	-	-	≤100
bark (A,C)	Particle size from 20 to 80	30	≤200
		40	≤300
woodchips (A,C)	Particle size from 5 to 30	30	≤200
		40	≤300
sand or gravel (A,C)	Particle size from 0,25 to 8	30	≤200
		40	≤300
synthetic attested (A,B,C)	Tested according to EN 1177		100

Product technical sheet

SOLO WD1448

Amount of safe surface corresponding with free fall height:

HIC <60 13,9 m²

HIC 100 21,3 m²

Data is subject to change without prior notice.

