

Installation Instructions

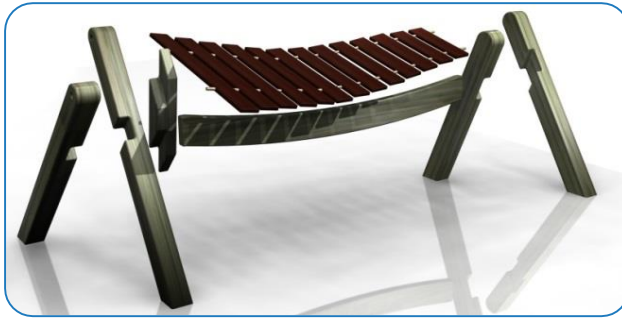

1. Assemble Akadinda frame comprising 2x 'X'-shaped legs and 1x horizontal beam. (See **Assembly Guide**). Cover 8 holes on horizontal beam using **4xBlack caps (1.1)**

2. Locate M8x80mm eye bolts through pre drilled holes using flat washers on both sides of the timber to prevent the fixing pulling into the timber. Secure in place with **M8 nyloc nuts**, cover 4 holes in ends using **4xBlack caps. (1.2)(1.3)**

3. Attach L Brackets to legs of frame with coach bolts provided. Pilot holes required to stop timber from splitting

4. Place Akadinda in desired location and **mark 4 holes** for surface fixing.

5. Fix to Surface using recommended ground anchors not supplied

6. Make sure all fixings are covered and secure using cover caps provided

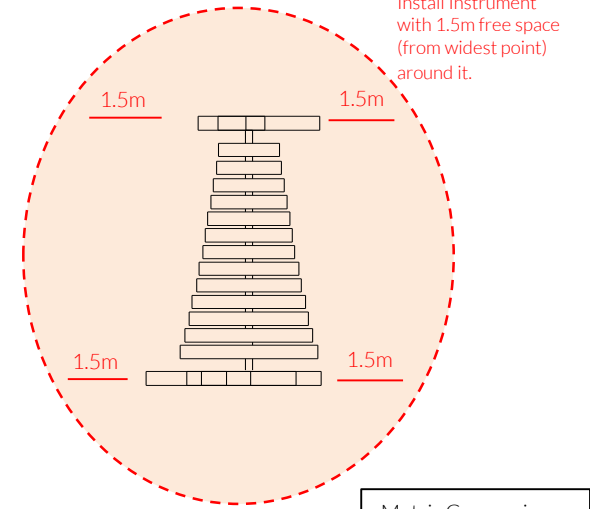

Install Instrument with 1.5m free space (from widest point) around it.

Metric Conversion:	
150mm/ 6"	
250mm/ 10"	
360mm/ 14"	
400mm/ 16"	
500mm/ 20"	
650mm/ 26"	
750mm/ 30"	
900mm/ 35"	
1.5m/ 59"	

Height to centre of notes:
KS0 3-5 500mm Depth 400mm
KS1 5-7 650mm Depth 250mm
KS2 7-11 750mm Depth 150mm
Adult 900mm Surface Mounted

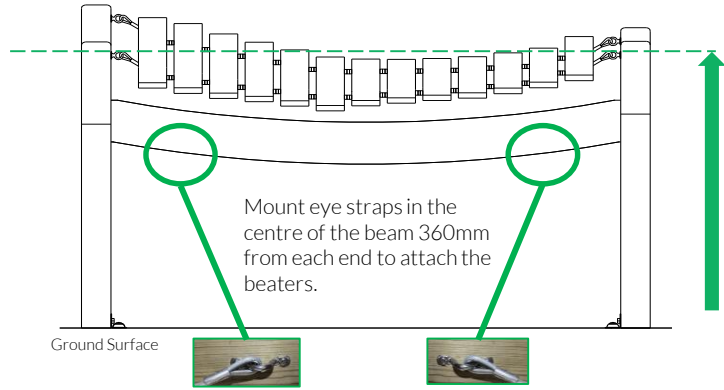

Weight of heaviest part **28kg (Frame)**

Surface Fixed
Akadinda
Page 1 of 2



Instrument Components:

- M10 Wedge Nut X2
- M10x30 SS Washer X2
- M8x25 SS Washer X8
- Eye Straps X2
- M8 Lock Nut X4
- Pin Torx 25 Driver Bit X1
- M10x130 Bolt X2
- 10x38mm Secure Screw X4
- Black Caps X8
- 5x70mm Screw X4

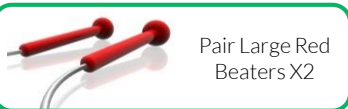

Pair Large Red Beaters X2

Surface Fix Components:

- M8x50 Coach Screw x8
- L Brackets x4
- 2 Part Cover Cap x4

Ground Anchors not supplied

Spares available from percussionplay.com or from your local distributor

48 Kg

Assembly Guide PPAKAD

Tools:



x1
TX 25 Driver Bit



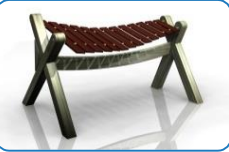





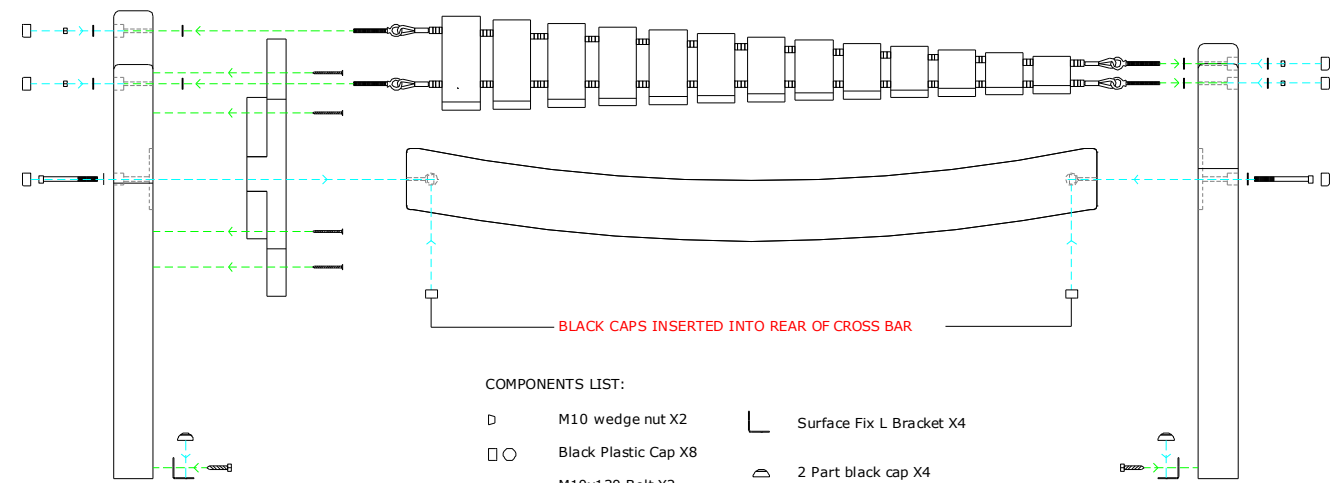

Surface Fixed
Akadinda
Page 2 of 2



Instrument Components:

-  M10 Wedge Nut X2
-  M10x30 SS Washer X2
-  M8x25 SS Washer X8
-  Eye Straps X2
-  M8 Lock Nut X4
-  5x40mm Secure Screw X4
-  M10x130 Bolt X2
-  5x70mm Screw X4
-  Black Caps X8



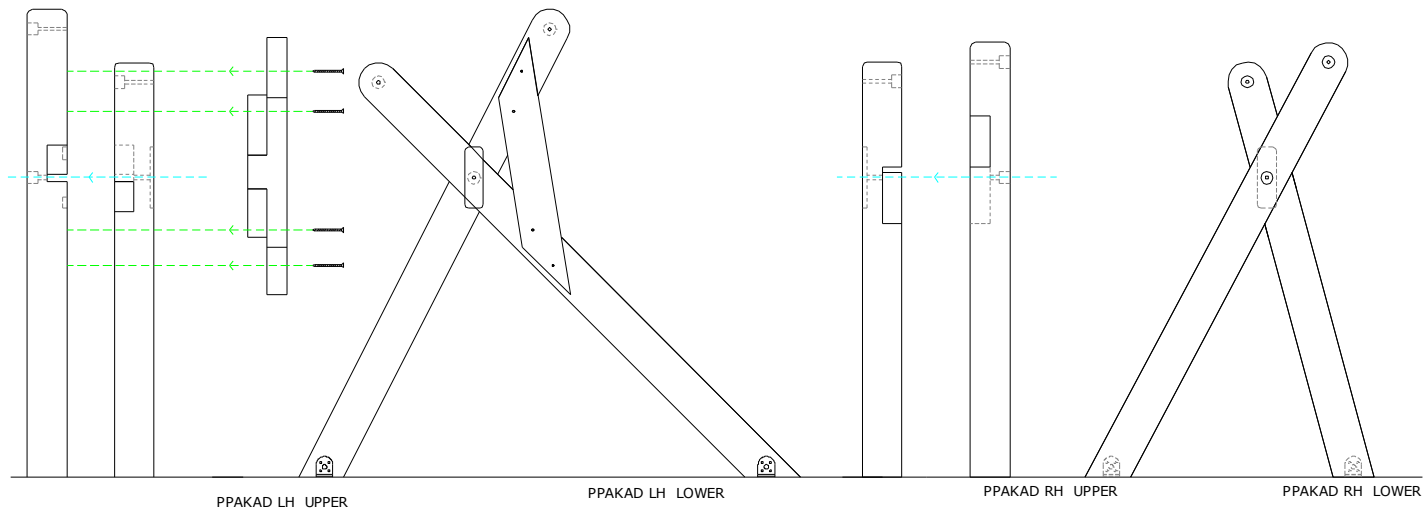

- COMPONENTS LIST:**
-  M10 wedge nut X2
 -  Surface Fix L Bracket X4
 -  Black Plastic Cap X8
 -  2 Part black cap X4
 -  M10x130 Bolt X2
 -  8x50 Coach screw X4
 -  M10x30 washer X2
 -  M8x25 washer X8
 -  5x70 screw X4
 -  M8 Nyloc nut X4



Pair Large Red Beaters X2

Surface Fix Components:

-  x4
M8x50 Coach Screw
-  x4
L Brackets
-  x4
2 Part Cover Cap

Ground Anchors not supplied

Spares available from percussionplay.com or from your local distributor

48 Kg